

SEW VERA VENUS
“A modern make on vintage style”
VeraVenus.com

Reversible Faux Fur Stole

Bow tied stole with centre front box pleats on both sides,. Ties have pom-poms on the ends.



Fabrics:

- 1/2 metre* faux fur 140cm wide.

The fur I used has a long 2.5cm/1" pile and a sturdy knitted backing. If using a lighter weight/ shorter pile fur you may wish to back it with a layer of cotton flannelette or even a light weight wadding to give it a plusher feel.

- 1/2 metre* 140cm wide fabric for inside and ties: For the lining a medium weight fabric with body works best, for example a firm brocade, cloque, duchess satin or similar. If using a thin fabric thicken it with a medium weight iron-on interfacing.

* Allow 3/4 metre if fur or fabric is less wide.

This pattern fits shoulders with an around-shoulder measurement of 104cm/42-42". (approx US 8-10/UK 10-12)
It is simply made bigger or smaller by adding to or subtracting from the pattern at the centre back seam.

Using a lovely plush fur and good weight of fabric for the lining is important to a successful result.



©VeraVenus 2015 All rights reserved

ՏԵՎ ՎԵՐԱՎԵՆՈՍ

“A modern make on vintage style”
VeraVenus.com

ՊԱՃԱՆԳ ԴՈՏՏՐԱՆԵՐԴՅՈՒՄ

Step 1: Adjust pattern:

Measure around your shoulders where a stole would sit. Measure the pattern from the sewing line at the centre front middle pleat notch to the centre back fold line. The 1/2 paper pattern should measure 1/2 of your around-shoulder measurement. Adjust the pattern size by adding or subtracting at the centre back.



Step 2: Cut fur- main stole piece and pom-poms:

The fur is cut along the outer cutting line marked on the 1/2 pattern. Place your fur backing side up on the table and lay the 1/2 pattern onto it. Anchor it in place with a few pins. Using chalk mark the centre back line and then draw around the rest of the pattern. Mark the pleat notches. Un-pin and flip the pattern over at the centre back line and draw the other half. Using small sharp scissors and cutting through the backing fabric only cut the stole out. Cut 2 pom-pom circles out now as well.

Step 3: Cut fabric-main pattern and tie pieces:

! Note that the fabric cutting line is 2cm inside the line used to cut the fur on the long top and bottom edges!

Fold your fabric in half wrong sides together so the 1/2 pattern fits on it with the centre back on the fold line. At this point you can either trim the pattern down along the fabric cutting lines marked on it OR after first chalk marking the edges onto your fabric draw a second line 2cm / 3/4” inside the chalked line to use as the new fur cutting line. The reason for this is that it gives a nicer rolled fur edge to the stole rather than a flat line where the two different materials meet.

Don't forget to mark the pleat notches too. Also cut out the two tie pieces.



Step 4: Sewing ties and pompoms:

With right sides together join the long edges of a tie to form a tube, turn right side out and press flat so the seam is on an edge. Bunch up one end of the tie, centre it on the backing side of a circle and hand sew securely in place. Repeat with the other tie and circle.

ՏԵՎ ՎԵՐԱՎԵՆՈՍ

“A modern make on vintage style”
VeraVenus.com



Using a strong thread hand sew a running stitch around the outer edge of each pompom circle. Pull the thread tight forming the gathers around the tie. You can stuff some scraps into the pompom as you pull it up if you think it needs it to keep a rounded shape. With your hand needle and thread sew back and forth through the tie and the pompom gathers a few times to attach them together.

! Make sure that enough length of tie has been left between where you first attached the tie and the gathered edge or the shape of the pompom will be distorted.

Step 5: Fabric sewing:

Pin the centre front notches together as arrowed to form an outward facing box pleat. Baste in place. On the wrong side of the pleat hand sew the two folds together with a criss-cross stitch for 5cm /2". This makes the pleat sit better when the stole is worn.



With the raw edges lined up place the tie ends onto the right side of each box pleat. Make a small tuck in the tie as necessary so its edges line up with the pleat folds. Machine baste in place.



SEW VERAVENUS

“A modern make on vintage style”
VeraVenus.com

Step 6: Bagging out fur and fabric:



On your main fur stole piece use small scissors to trim the fur close to the backing along the seam allowance. Do this all the way around, teasing the cut fur away with your fingers. Messy but doing this helps reduce bulk especially along the fronts.

*With thinner furs you can skip this trimming.

Make centre front box pleats in the fur like you did in the fabric. Also hand catch the pleat folds together on the wrong side just like you did the fabric ones.



With right sides together pin the fabric to the fur along the top and bottom long edges only. The fur may need to be eased in slightly onto the fabric as the knit backing often stretches a bit. Leave the fronts open for now and also leave a gap of at least 20cm somewhere along one of these seams



to turn the stole through when bagging out is complete. Use a large stitch setting to make it easier to tease out caught in fur later after you turn it all right side out. A walking foot is certainly helpful but not necessary.

!For thick furs use a larger sewing machine needle!

You may find it easier to sew with the fur on top and the fabric underneath so you can see if the fur fabric is forming tucks anywhere and if so to be able to smooth them out with your fingers as you sew.

SEW VERAVENUS

“A modern make on vintage style”

VeraVenus.com

Next join the fur and fabric along the two fronts. The two seams you just sewed will need to be rolled in towards the fabric to fit as it was cut that 2cm wider top and bottom



NB- in this photo I hadn't yet crossed stitched the inside of the pleats together as pictured in Step 5.

!The front pleats are very thick to sew over especially with the tie ends sandwiched in as well. Hand basting it together first will help hold things in place much better than just pinning!

Turning your sewing machine wheel by hand to 'walk' the needle through the thickest areas will help too.

Even though my fur and fabric was very thick I did manage to get it through my elderly domestic Bernina ... but hand sewing this area with strong thread and back stitches is certainly another option and possibly a less aggravating one. In any event make sure the sewing is very secure as the ties do get some strain while being tied and worn.

After the front edges have been sewn carefully turn the stole right side out through that 20cm gap I hope you remembered to leave open and coax the four front corners into shape with your fingers.

Hand stitch the gap closed. Using a sturdy pin or the tip of small scissors (in the closed position), carefully tease out any fur fibres that may have been caught in the seams.

There it is, finished.

Enjoy!

About sourcing fake furs: Good to great quality faux furs just aren't cheap! Occasionally I have stumbled on a bargain in a fabric store but have mostly found fab furs at better prices online. And at least this stole only takes 1/2 metre. Often online suppliers will send out a few small samples for free or the cost of postage so you can check colour and quality. Internet shops that sell primarily to teddy bear / stuffed toy makers are worth checking out too.

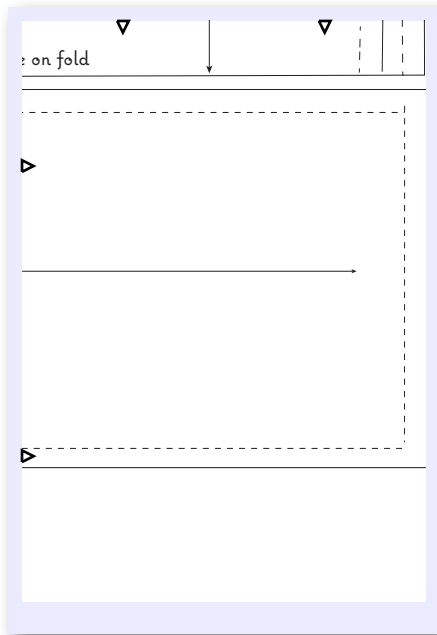
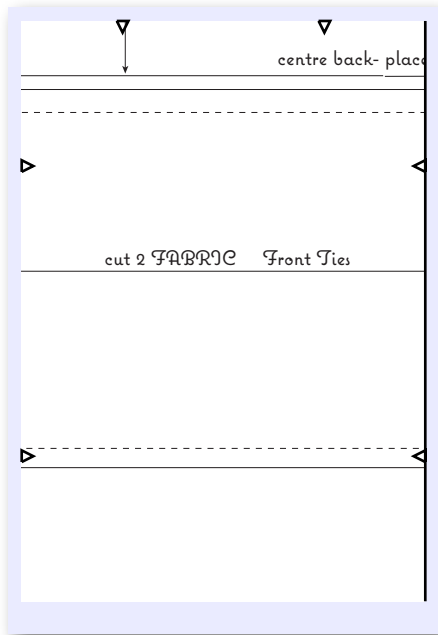
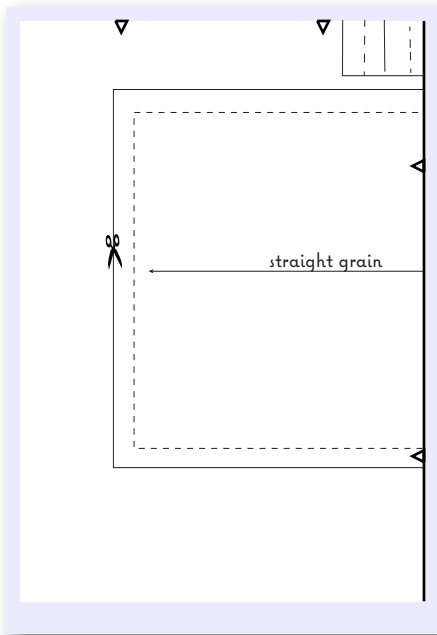
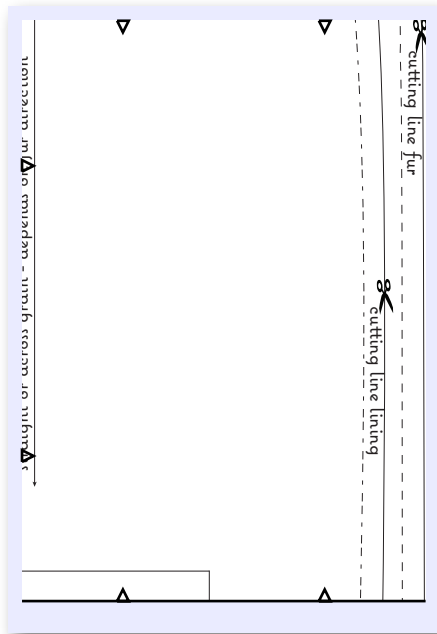
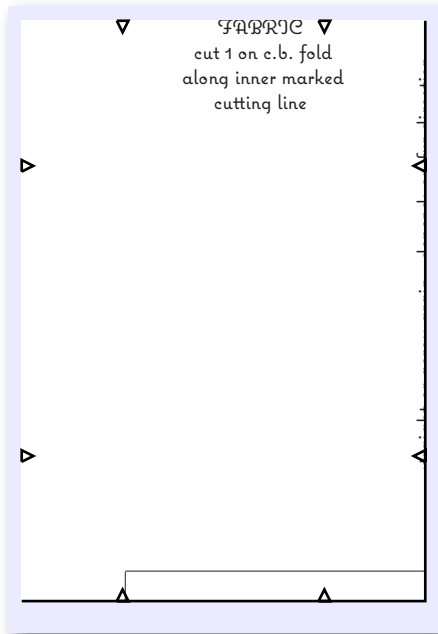
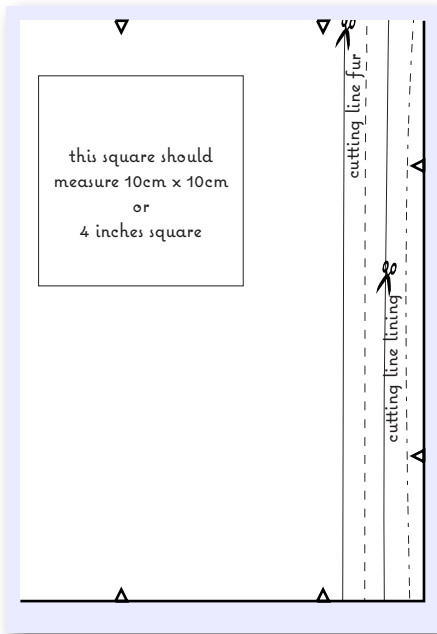
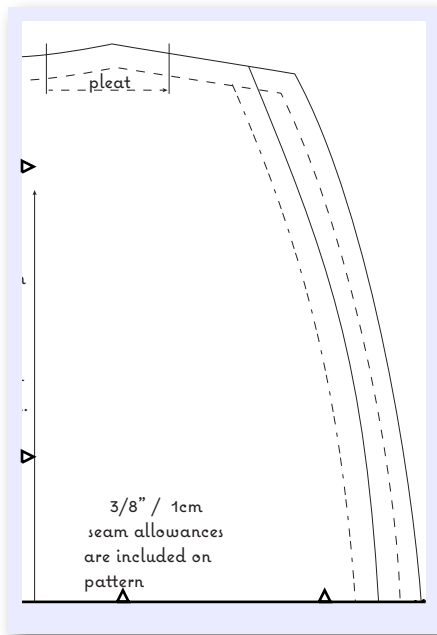
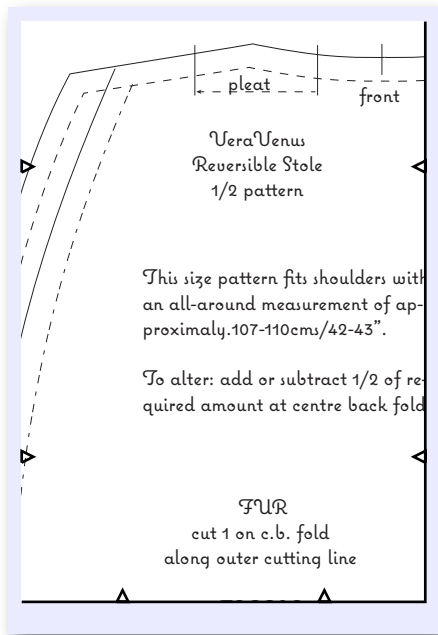
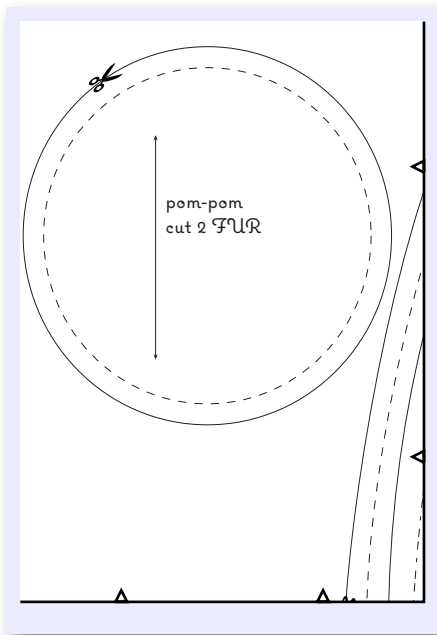

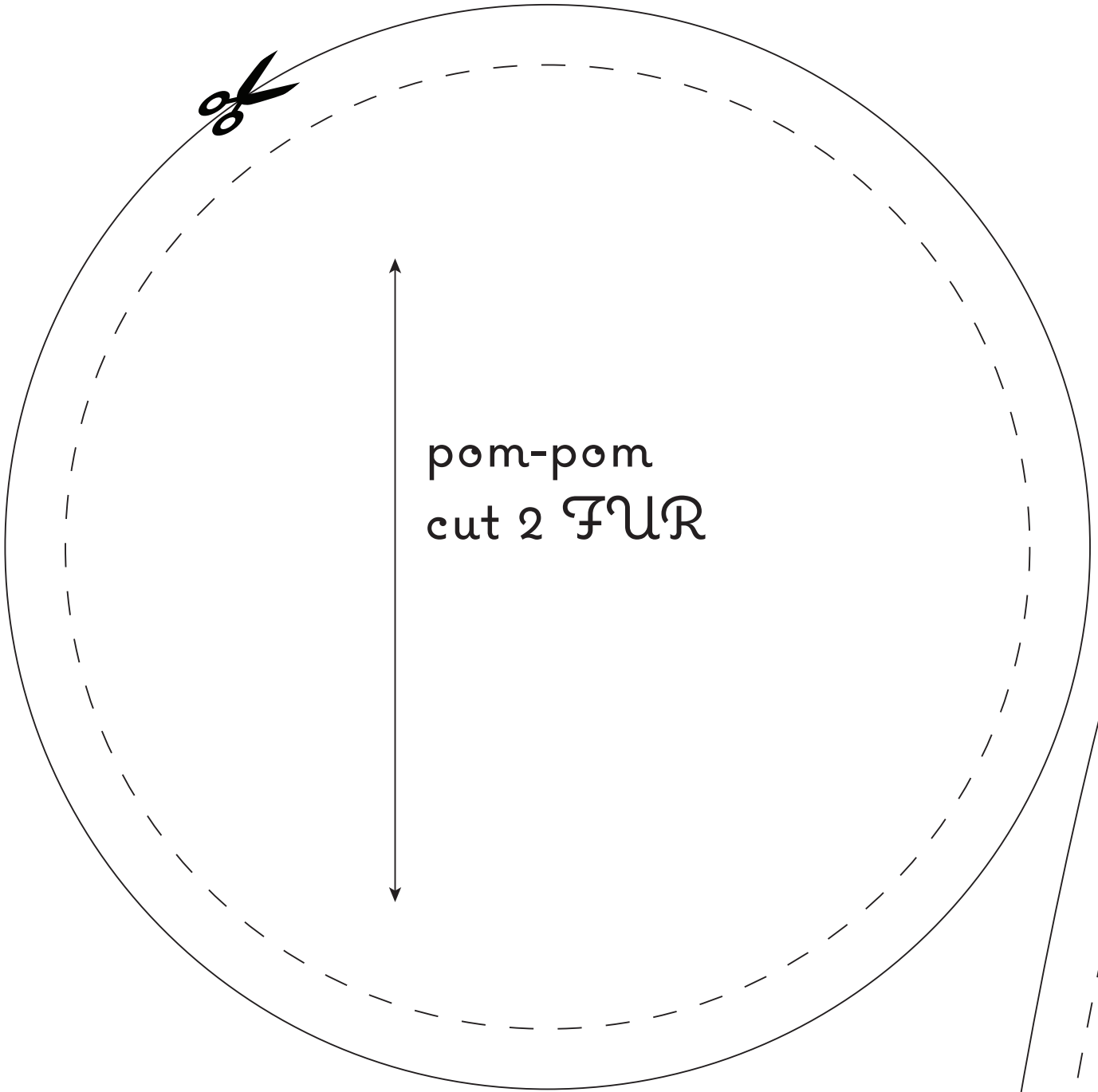

pom-pom
cut 2 FUR

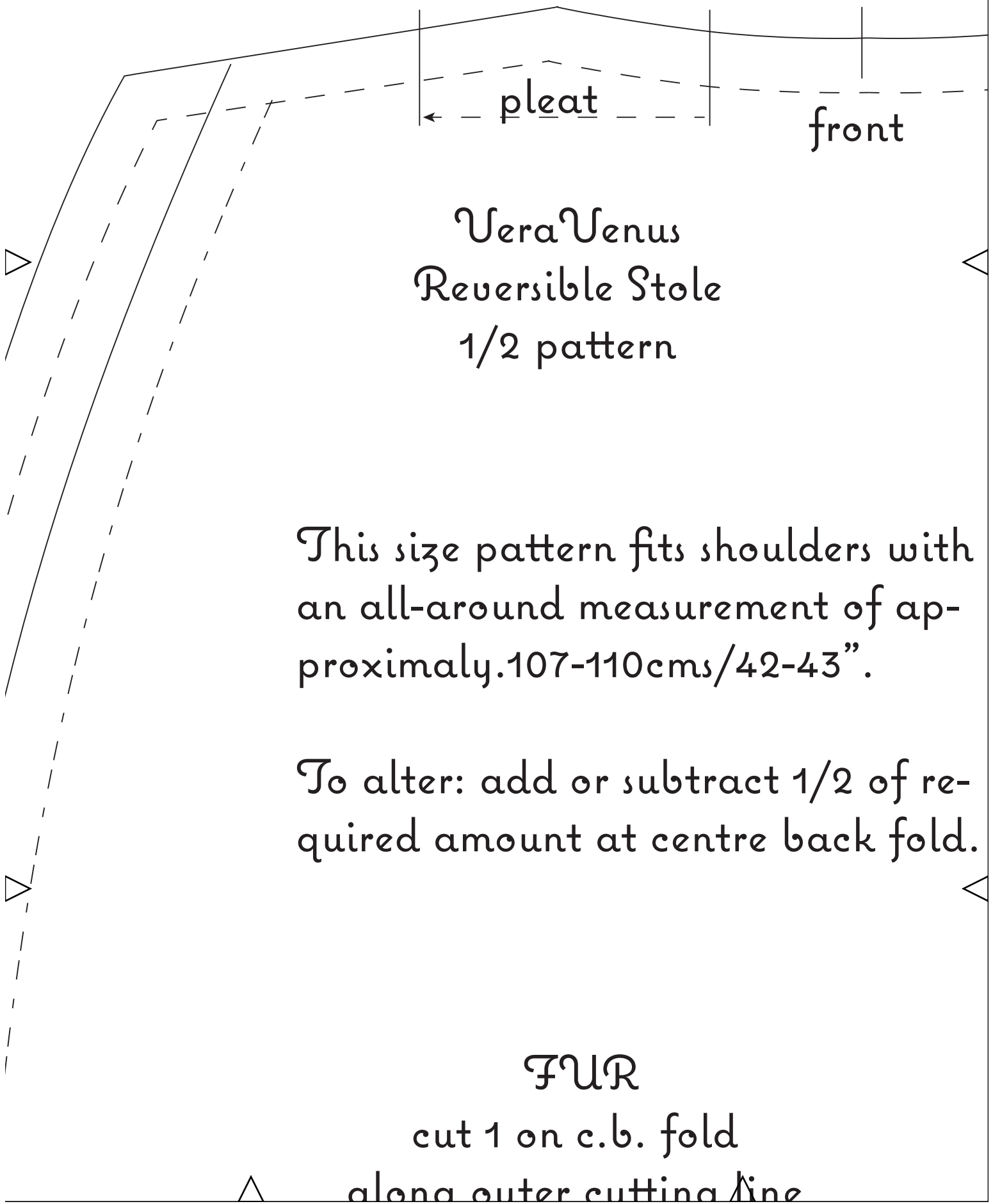

← pleat front

Vera Venus
Reversible Stole
1/2 pattern

This size pattern fits shoulders with an all-around measurement of approximately 107-110cms/42-43".

To alter: add or subtract 1/2 of required amount at centre back fold.

FUR

cut 1 on c.b. fold

along outer cutting line

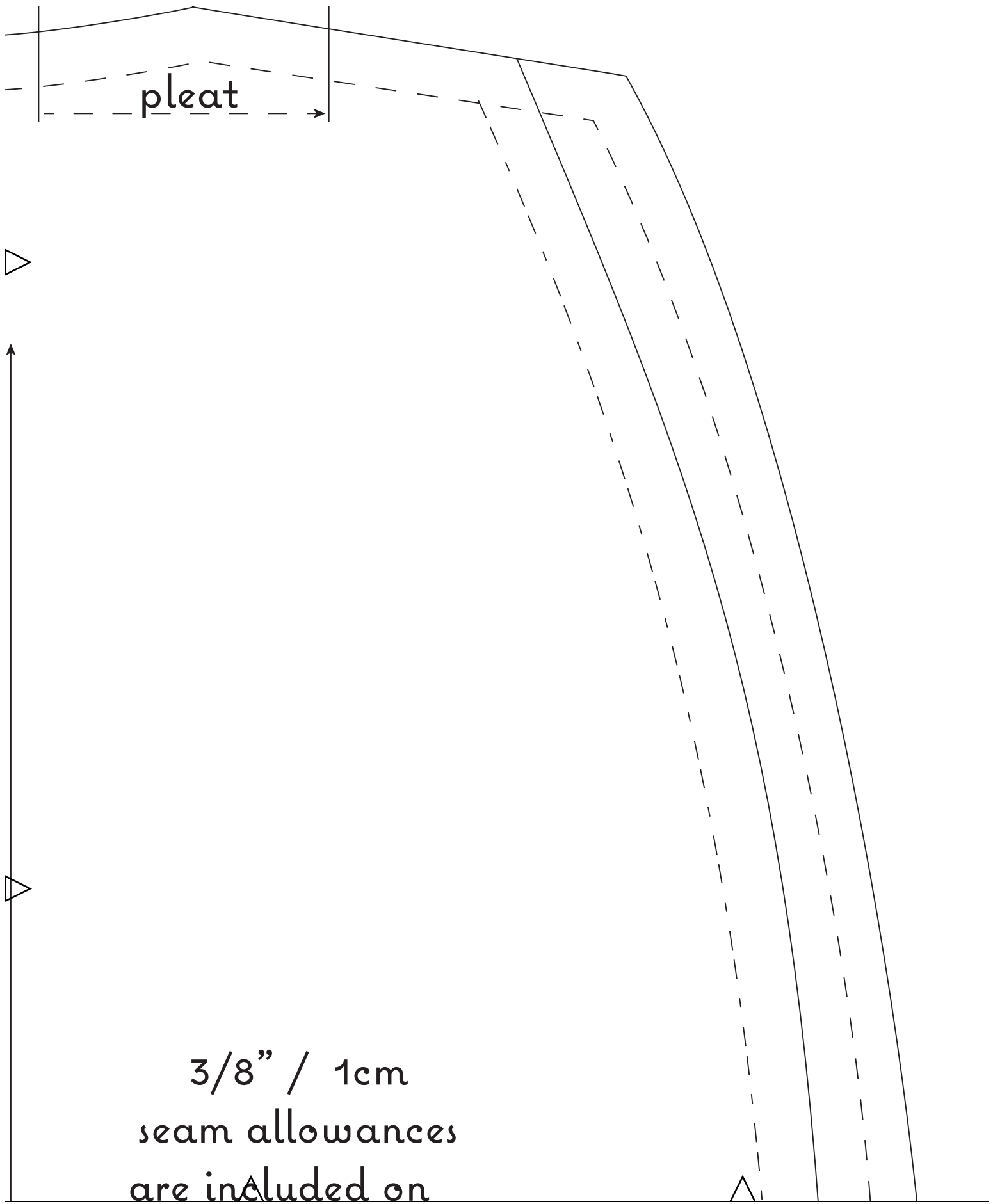

pleat

3/8" / 1cm
seam allowances
are included on



this square should
measure 10cm x 10cm
or
4 inches square



cutting line fur



cutting line lining





along outer cutting line



FABRIC

cut 1 on c.b. fold
along inner marked
cutting line



straight or across grain - depends on fur direction



pattern ▾



✂ cutting line fur

✂ cutting line lining

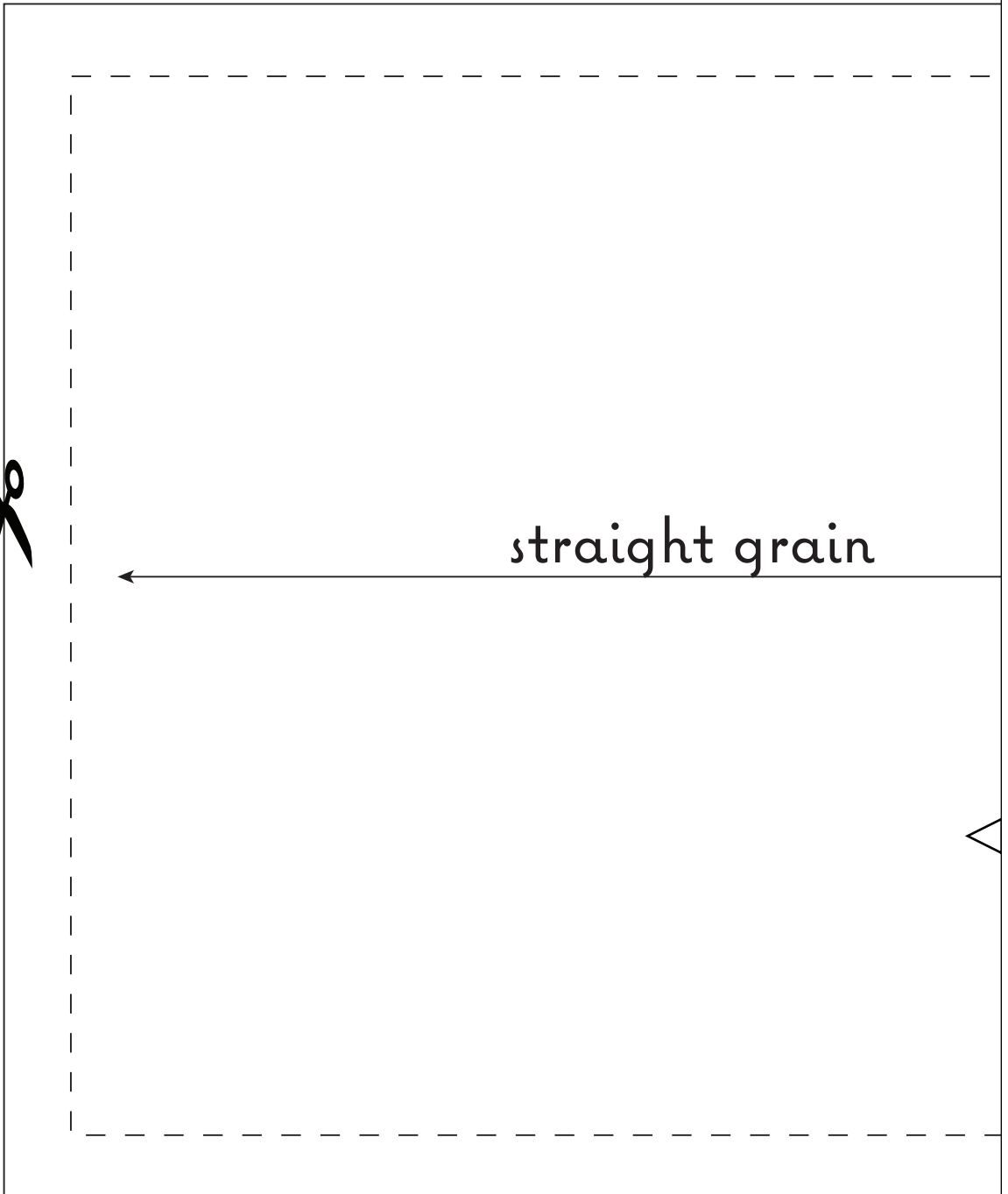
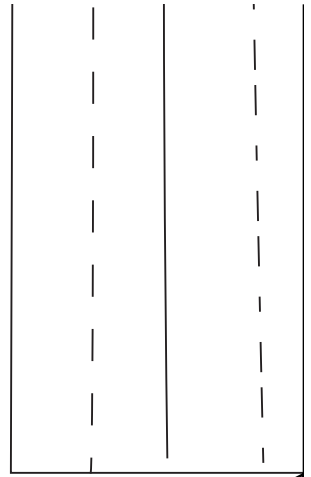

straight grain

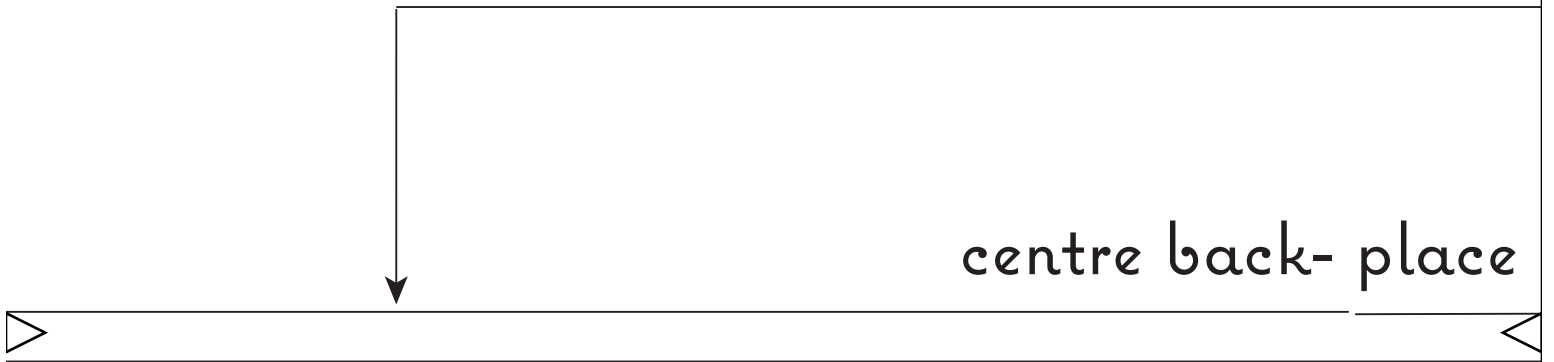

cut 2 FABRIC Front Ties

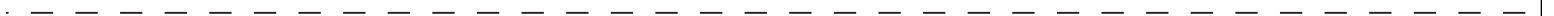



on fold

